

# Polarization Dependent Loss Measurement of Passive Optical Components

Application Note

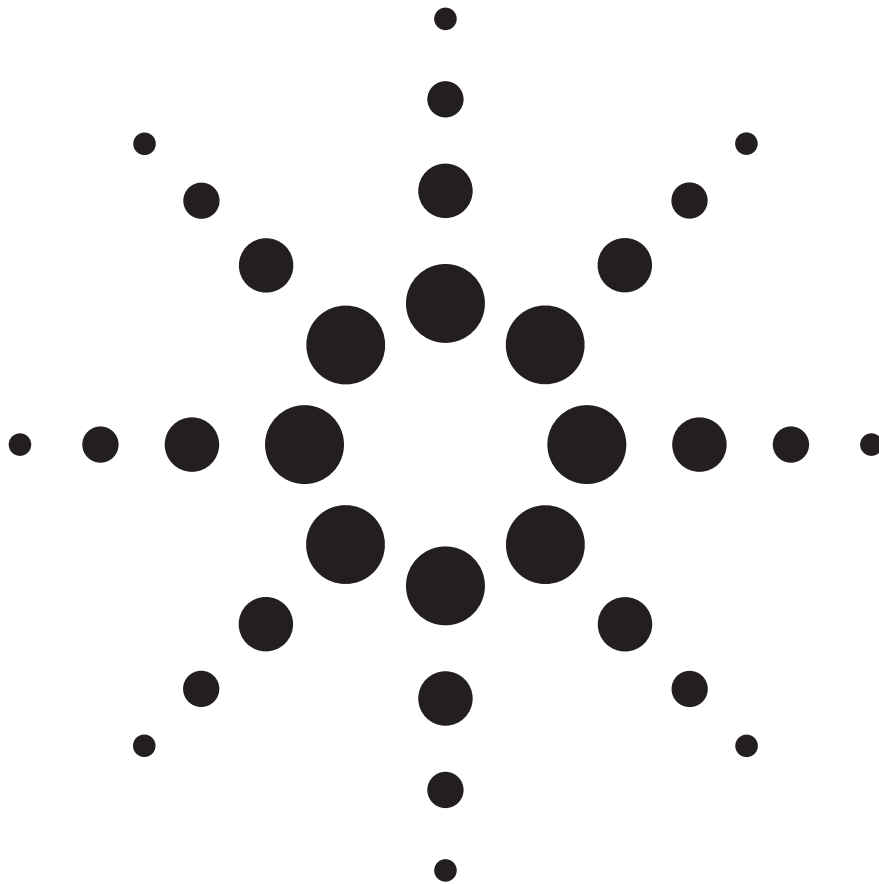

## Abstract

The measurement of Polarization Dependent Loss has gained a great deal of attention among component manufacturers.

This Application Brief discusses two different measurement techniques, the Polarization Scanning technique, and the Mueller Method, and examines practical implementation difficulties.



**Agilent Technologies**

## Introduction

Fiber optic networks are the present and future medium of choice for high-speed, high-volume data transmission. The growth in demand for greater data throughput requires greater bandwidth and smaller channel spacing.

The rapid development of fiber-optic network technology is driven by dramatic advances in the design and manufacture of both active and passive optical devices. The tremendous need for higher data transmission rates has always driven the development of new optical components to the limits of existing technology.

The development and testing of new optical components has become more challenging and complex, for example:

- Channel spacing is constantly being reduced, so wavelength dependent measurements must be increasingly accurate.
- The complexity of multi-channel test systems increases as the number of channels increases.
- The extension of optical data transmission into new spectral regions, such as the L-band, involves the development of both optical components, and the equipment required for testing them.
- The performance of DWDM systems is increasingly influenced by the polarization of light wave signals. The increasing length of fiber links has focused attention on new test parameters, such as polarization dependent loss, which is a signal distortion that accumulates over distance.
- Higher data transmission rates (10 Gbit/sec or 40Gbit/sec) require shorter pulse duration. In the frequency domain, this results in a broader spectrum. High transmission quality requires broader spectral areas of low polarization dependent loss, to avoid attenuation variations for different spectral components.

In addition, due to the rapid growth in the fiber-optic technology market, manufacturers must ramp up production volumes by increasing manufacturing capacity, and by shortening test time while not compromising test accuracy.

This Application Note focuses on the evaluation of two polarization dependent loss measurement techniques that are suitable for deployment in the high volume manufacture of passive optical components. The advantages and disadvantages of each technique is discussed. Finally, a typical applied measurement solution is described in detail.

First, polarization dependent loss is briefly defined, and its effects in fiber-optic transmission links described.

## Polarization Dependent Loss – Definition

Polarization dependent loss is a measure of the peak-to-peak difference in transmission of an optical component or system with respect to all possible states of polarization. It is the ratio of the maximum and the minimum transmission of an optical device with respect to all polarization states.

Polarization Dependent Loss, PDL, is defined as:

$$PDL_{dB} = 10 * \log\left(\frac{P_{Max}}{P_{Min}}\right)$$

**Equation 1: Definition of polarization dependent loss.**

In Figure 1, the effect of applying all possible states of polarization to an optical component is shown. The polarization of the constant, and fully polarized, input signal is varied. As the polarization of the incident light varies, the output signal shows a corresponding change in power.

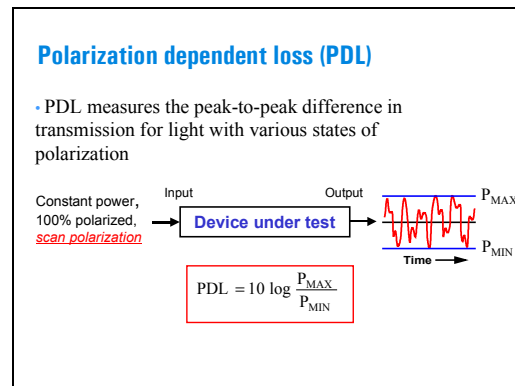

**Figure 1: Polarization Dependent Loss of passive optical components.**

**The output power variation is the result of the variation in the polarization of the incident light wave signal.**

## Causes of Polarization Dependent Loss

The polarization dependence of the transmission properties of optical components has many sources. Some of the most common effects are:

- Dichroism
- Fiber bending
- Angled optical interfaces
- Oblique reflection.

## Polarization Dependent Loss in optical transmission networks

All the above effects appear in the standard optical components used in fiber-optic networks.

A typical structure of a fiber-optic transmission network link is shown in Figure 2. The transmission link includes a number of different passive and active components. The most common passive devices that exhibit PDL include optical couplers, isolators, wavelength-division multiplexers (WDM) and photodetectors.

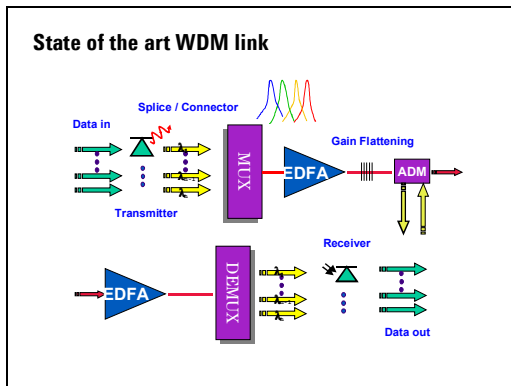

Figure 2: Typical WDM link in fiber optic networks.

The polarization state that exhibits maximum loss (that is, minimum transmission) through one component is generally not the same as for other components in the transmission link.

Furthermore, the polarization state is not maintained along a fiber. The evolution of polarization along a fiber is of a completely statistical nature and, in consequence, is totally unpredictable.

Even if the PDL axis of every component is aligned, this does not correspond to the minimum or maximum effect on polarization sensitive transmission. Since PDL effects build up in an uncontrolled manner, PDL can lead to a degradation of the transmission quality of the fiber-optic

link, or even to a failure of the optical system. Therefore, modern fiber-optic communication systems require components with low PDL.

Consequently, the measurement of PDL has attracted enormous attention from component manufacturers. The need for PDL test solutions is accompanied by the requirements of short measurement time, high accuracy and high reliability.

In the following, two PDL measurement techniques are described and evaluated for their suitability for modern high-volume manufacturing.

## Measurement techniques

In the context of passive component testing during component manufacture, two techniques for determining the PDL of a device under test (DUT) are recommended: The Polarization Scanning technique, and the Mueller Method. While the Polarization Scanning technique is found suitable for PDL measurements at specific wavelengths, for many wavelength points in a broad wavelength range the Mueller Method shows clear advantages. Both techniques deserve a more in-depth treatment.

## The Polarization Scanning technique

The Polarization Scanning technique is the fundamental method for measuring PDL.

The DUT is exposed to all states of polarization and the transmission is measured with a power meter. The maximum and minimum transmission through the DUT can directly be measured. The PDL can then be calculated using Equation 1.

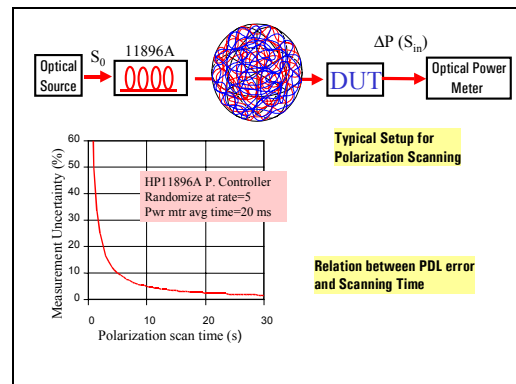

Figure 3: Setup of a PDL measurement using the Polarization Scanning technique.

The graph shows how the PDL measurement uncertainty depends on the measurement time.

Exposing the DUT to all states of polarization is all but impossible. In practice, a number of polarization states are generated at a scan rate that is suitable for the power meter averaging time. The longer a polarization scan takes, as the transmission through the DUT is obtained for more polarization states, the smaller the uncertainty of the PDL measurement [1]. This is demonstrated by the graph in Figure 3. At some point, increasing the measurement time does not yield significantly improved measurement accuracy. Here, where the polarization controller's randomize rate is 5 and the power meter's averaging time is 20ms, a measurement uncertainty of 5% requires a polarization scan time of 10s. Increasing the measurement time to 20s, (that is, measuring over twice the number of polarization states) results in a measurement uncertainty of 3%, an improvement of only 2%. Consequently, improving PDL measurement uncertainty must always be considered in the context of the affect on measurement time.

A typical PDL measurement setup employing polarization scanning is shown in Figure 3. The source produces nearly fully polarized light. The 11896A Polarization Controller transforms the polarization by means of four motorized fiber loops. The movement of the fiber loops causes a variation in the birefringence of the fiber, which results in variation of the polarization state. The different rotational speeds of the fiber loops generate polarization states in a pseudo-random manner. The 11896A Polarization Controller provides eight different scan rates, where the fastest scan is denoted by rate 8.

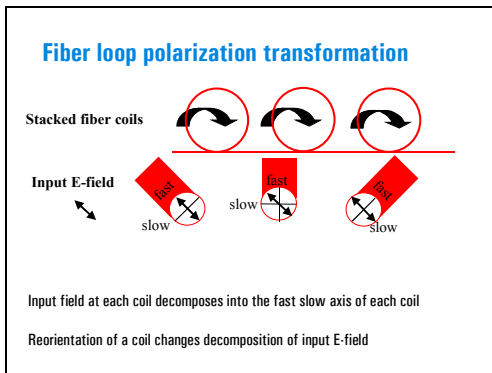

Figure 4: Fiber loop polarization transformation, shown on an example with three fiber loops.

Setting the correct polarization scan rate with respect to the averaging time of the power meter is critical. The polarization scan rate dictates how rapidly the polarization of the light wave signal is changed. A faster scan rate generates more polarization states in a given time interval, so might decrease the duration of a measurement. However, if the polarization scan rate is too fast with respect to the averaging time of the power meter, results

are falsified. At faster scan rates, the power meter averages over more polarization states; a maximum or minimum transmission could be averaged out. It is clear from Equation 1 that an error in maximum or minimum transmission value directly affects the PDL value obtained.

Averaging time is also critical in terms of noise. The signal-to-noise ratio is proportional to the square root of the averaging time. Clearly, choosing the optimum averaging time is a trade-off between the quality of the measurement in terms of noise and the measurement time. How averaging time affects the PDL results is demonstrated in Figure 5.

The three measurement examples at various averaging times show that with a small averaging time, such as 100μs, the quality of the measurement is degraded by noise. On the other hand, a long averaging time provides no visible improvement of the measurement results.

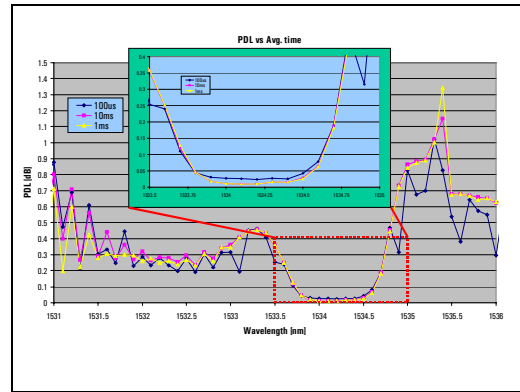
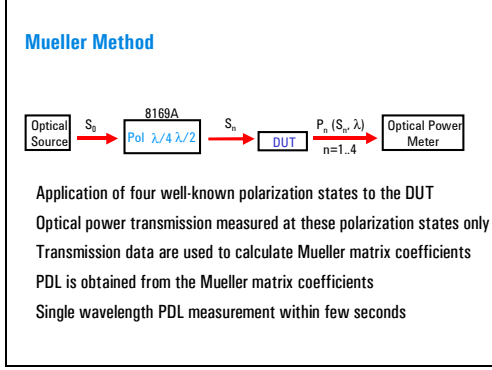

Figure 5: Polarization Scanning with three different averaging times: 100us, 1ms, and 10ms.

## The Mueller Method

A different approach to the measurement of PDL is to determine the Mueller matrix for the DUT. The technique is therefore known as the Mueller Method.

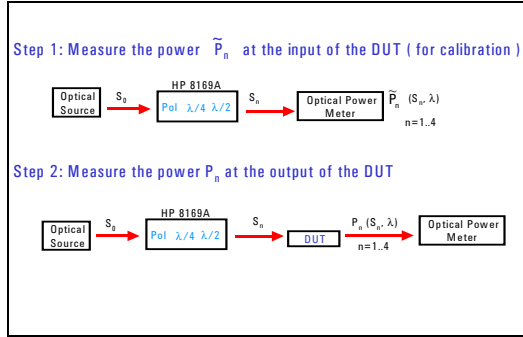

**Figure 6: Principle of a PDL Measurement using the Mueller Method.**

The Mueller Method determines PDL by exposing the DUT to only four, but well-known, states of polarization. The four polarization states are chosen to be LHP (linear horizontal polarized), LVP (linear vertical polarized), L+45 (Linear +45 degrees), RHC (right hand circular). The PDL is calculated from the transmission results.

This approach was first introduced in Reference [2]. Additional Information is provided by Reference [3].

The PDL measurement procedure has two steps, a reference measurement and the DUT measurement, as illustrated by Figure 7.



**Figure 7: Measurement Procedure of Mueller method: Reference and DUT measurement.**

First, the optical power at the four defined polarization states is measured. In the second step, the same four polarization states are applied to the DUT and the transmitted optical power is measured.

The Mueller matrix describes the polarization and power transmission properties of the DUT. The relationship between an input Stokes vector and output Stokes vector of a DUT can be written as:

$$S_{out} = M_{DUT} * S_{in}$$

where  $M_{DUT}$  is the Mueller matrix of the device.

The Mueller matrix is a 4x4 matrix. The four first-row coefficients of the Mueller matrix describe the power transmission of a device, which is sufficient to obtain the PDL.

As stated previously, the reference measurement determines the power of the input Stokes vector. The DUT measurement yields the total power transmitted through the DUT. When measured for the four polarization states, a system of linear equations can be solved to determine the desired coefficients of the Mueller matrix, as shown in Figure 8.

From these coefficients, the maximum and minimum transmission can be derived, as shown in Figure 9, from which the PDL can be calculated, as shown in Equation 1.

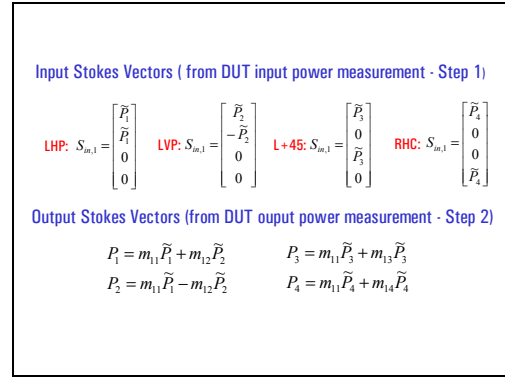

**Figure 8: With the power measurement results, a system of linear equations can be solved.**

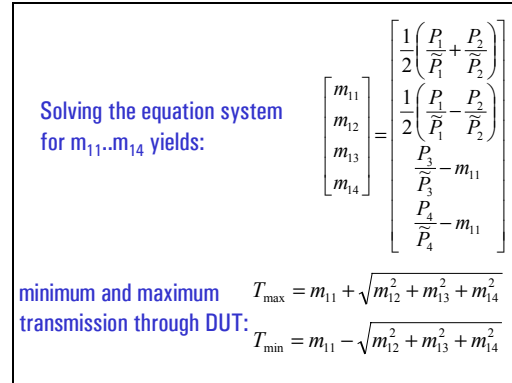

**Figure 9: Calculation of minimum and maximum transmission.**

The four polarization states are synthesized by an 8169A Polarization Controller. The polarization controller consists of a polarizer, and two retarder plates (one quarter-wave, and one half-wave). All elements are rotatable; the axis of rotation being parallel to the direction of light propagation.

The polarizer generates a linear polarization state, which the retarder plates transform into any other polarization state. Desired polarization states are obtained by setting the retarder plates to specific angles.

The polarization controller exhibits a polarization dependent loss. The PDL of the polarization controller is specified to within  $\pm 0.03\text{dB}$ . The reference measurement records the absolute power at each of the four polarization states. If the system is unchanged, each polarization state has the same output power during the DUT measurement as during the reference measurement. Hence, power variation across polarization is taken care of by the reference measurement.

## Advanced PDL measurement

### Requirements for maximum accuracy

Regardless of which measurement technique is used, to achieve the highest possible accuracy, its setup must meet certain requirements:

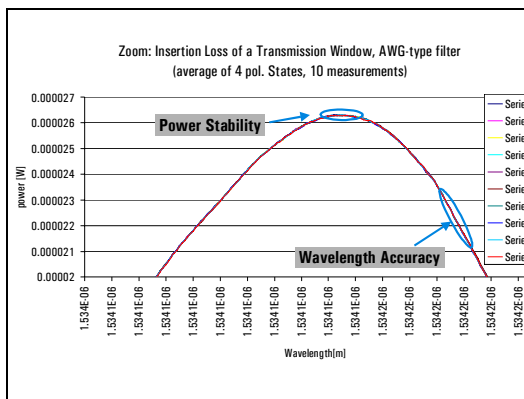

**Figure 10: Evaluating the measurement setup includes wavelength repeatability and power stability.**

- The tunable laser source must have a stable power output. Any variation in the output power of the laser source is not recognized in a PDL measurement, and may be misconstrued as polarization sensitivity of the DUT.
- Wavelength accuracy and wavelength repeatability play important roles in the quality of a measurement. Wavelength accuracy determines the absolute location of the filter curve along the wavelength axis. Wavelength repeatability is especially important for the Mueller Method, where the filter curve is measured four times at different input polarization states. Any deviation in wavelength between the four measurement results can severely affect the final PDL result.

Power stability and wavelength repeatability can easily be qualified by repeated measurement of a filter transmission curve at a fixed input polarization, as demonstrated in Figure 10. Power stability is best evaluated at the peak of the filter transmission curve. The overlap at the slope of multiple filter curves is a valuable measure of wavelength repeatability. A sample measurement series is shown in Figure 11.

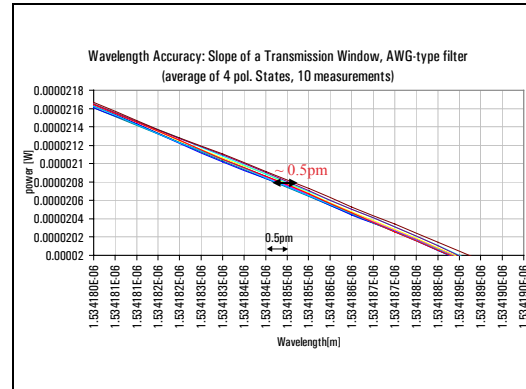

**Figure 11: Demonstration of the wavelength repeatability of 10 wavelength sweeps.**

The detector in the test setup also plays an important role. As stated in the introduction, photodetectors are among the components that exhibit polarization dependence. Thus, it is essential to use detectors with low PDL. As mentioned earlier, the PDL of different components combines in an uncontrolled manner, so the PDL of the detector can significantly affect the PDL measurement. Moreover, spectral ripple of the power detectors can degrade the measurement quality.

The latest Agilent power meter modules provide the flexibility needed to meet the requirements of different test environments. The choice of power sensor module is driven by the measurement priorities. For the highest accuracy, the single-channel optical power sensors (81633A, 81634A), or optical power heads (8162xA), are preferred. The dual-channel power sensors (81635A) provide an economical solution with slightly lower performance. The intrinsic PDL of the Agilent 81635A dual-channel power sensor module is specified as typ.  $\pm 0.015\text{dB}$ . However, the two channels of each power sensor save space in the test environment.

Where the requirement is for the highest possible accuracy, optical heads, with their low intrinsic PDL (typ.  $\pm 0.002\text{dB}$ ), provide the best solution. When used with a dual-channel interface module, optical heads meet demands for the highest accuracy while providing an economic solution in terms of the mainframe's module capacity.

Using single-channel power sensors, with their low PDL, can meet a requirement for low uncertainty. However, for a given number of channels, twice as many mainframe slots are required than for a dual-channel solution. Extra mainframes may be required to host all the power sensor modules.

Not only the detector, but also every other passive component in the setup can influence the PDL measurement. Therefore, to reduce the measurement uncertainty, it is essential to minimize the number of optical interfaces and components. Open angled connectors, for example, have an intrinsic PDL dependent on the angle between the front-end surface and the plane normal to the direction of light propagation. An open  $8^\circ$  angled connector exhibits a PDL of 0.019dB. Used as the final connector between the DUT and power meter module, the intrinsic PDL of the connector influences the measurement result. This effect cannot be calibrated out, so it is essential to use a straight connector to the power meter module.

## PDL over Wavelength

Most often, the PDL of a DUT at different wavelengths must be measured.

Generally, the Polarization Scanning technique can be shown to be best suited for PDL measurement at single wavelengths, and the Mueller Method for PDL measurement over a wavelength range, as shown in Figure 12.

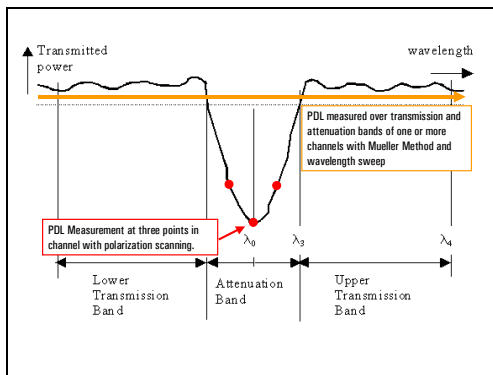

**Figure 12: Measuring PDL over wavelength with polarization scanning and Mueller method.**

The Polarization Scanning technique exposes the DUT to many states of polarization, so the PDL can be measured only at one wavelength at a time. It is clear that capturing the PDL of a DUT at many wavelengths can quickly become very time-consuming. However, if the PDL is only required at certain points, such as the center wavelength

or the 3dB bandwidth wavelengths of a passband, the Polarization Scanning technique is sufficiently fast.

Compared to the Mueller Method, the Polarization Scanning technique is relatively easy-to-implement and does not involve extensive mathematical calculations, excepting Equation 1. The Polarization Scanning technique is the preferred solution for this case.

The 11896A Polarization Controller is specified for operation in a broad wavelength range (1250nm – 1600nm). The fiber-based design of the polarization controller means that wavelength effects can be presumed to be negligible.

The laser source employed depends on the wavelength accuracy required and the range of wavelengths of interest.

For example, the Agilent 81689A compact tunable laser source covers a 50nm wide range (1520nm – 1570nm). The lack of continuous sweep capability does not play a role, because the Polarization Scanning technique only allows the wavelength range to be covered in steps. Furthermore, the transmission properties of the DUT are measured only at specific wavelengths, which need not be equally spaced.

In contrast, the Mueller Method, in conjunction with a continuous wavelength scan, should be used where an entire channel, or even a number of channels, must be characterized for PDL. In other words, where there are a large number of wavelength points with fixed spacing.

The Agilent 81680A tunable laser source, designed for passive component test in the C-band, is capable of continuous wavelength scan, which decreases measurement time when many wavelength points must be measured. In addition, this laser source has high dynamic range, low power fluctuations over time, as well as outstanding wavelength accuracy and repeatability.

Despite the advantage in measurement time, using the Mueller Method with a continuous wavelength scan is tricky.

As mentioned previously, the 8169A Polarization Controller synthesizes polarization states using a polarizer and two wave plates, a  $\lambda/4$  and a  $\lambda/2$  retarder. The design wavelength of the retarders is 1540nm. Only at this wavelength do the wave plates act strictly as  $\lambda/4$  and  $\lambda/2$  retarders. To produce the four defined polarization states for other wavelengths, the settings of the retarders must be corrected. However, this correction is impossible during a continuous wavelength scan. One way to account for the wavelength dependence of the generated

polarization states is to generalize the equation system described in Figure 8 in terms of the applied Stokes vectors. However, solving the equation for the Mueller coefficients turns out to be more difficult.

Theoretical investigations have shown that the wavelength dependent retardation of the  $\lambda/4$  and a  $\lambda/2$  retarder plates is less critical than source output power variations.

A second complication is that the transmission of the 8169A Polarization Controller's polarizer depends on the polarization of the incident light. During wavelength scanning, there is a periodic change in the input polarization state caused by the retarding property of the fiber. This means that the transmission through the polarizer is periodic over wavelength, as shown in Figure 13.

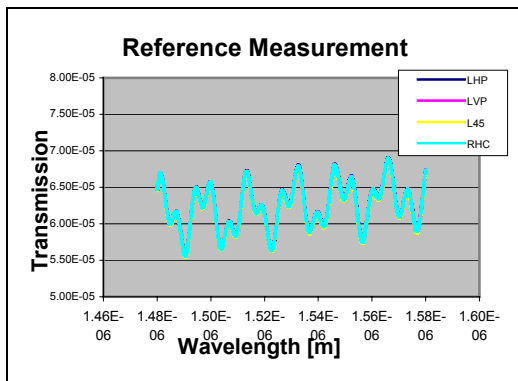

**Figure 13: Müller method: Periodic variation in output power of the polarization controller.**

In principle, using polarization-maintaining (PM) fiber should reduce this periodic variation in power transmission. The signal generated by the laser is linearly polarized. This linear polarization state is maintained because the 81640A and 81680A tunable laser sources have PM fiber pigtailed optical outputs. If the linearly polarized light were coupled exactly into a principle axis of the PM fiber, the state of polarization would remain constant. However, the 8169A polarization controller contains a single mode fiber connection from the optical input to the polarizer. Even if a PM fiber were used between the TLS and the polarization controller, a variation of polarization state over wavelength occurs within the polarization controller itself. Most critical, however, is the coupling into the PM fiber. Unless the PM fibers' principal axes are very well aligned, an even stronger variation of the polarization state over wavelength arises from the high birefringence of PM fiber. The consequence is a power variation with a shorter period and a higher peak-to-peak amplitude change over wavelength. A comparison of the output power over

wavelength between SM fiber and PM fiber are shown in Figure 14. This illustrates a worst-case example of the impact PM fiber can have on the reference measurement.

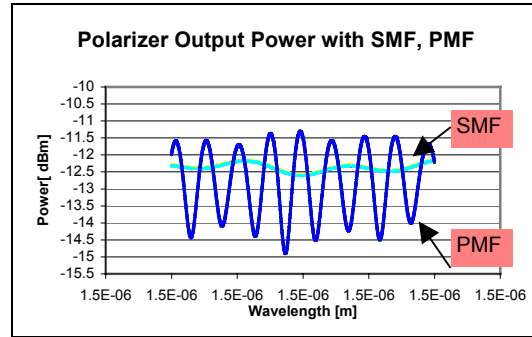

**Figure 14: Polarizer output power measured with SM fiber and PM fiber**

PM fiber should only be used if the linear polarization of light from the laser source can be maintained along the PM fiber between the source and the polarization controller. This depends primarily on the alignment of the connectors to the PM fiber's principal axis. In worst-case scenarios, PM fiber introduces more uncertainty to the measurements and decreases the quality of the PDL results.

Power transmission variation does not affect the final PDL measurement if it is equal for both the reference measurement and the DUT measurement. Provided the fiber from the source to the polarization controller is kept fixed, the evolution of the polarization state over wavelength is constant. However, any movement of the fiber between the two steps of the PDL measurement changes the polarization transformation characteristics of the fiber. This produces a wavelength and amplitude shift of the periodic power variation that is not reflected by the initial reference measurement.

The measurement is even more affected by a PM fiber if the linear polarization state of light from the laser source is not fully coupled into one of the fiber's principal axes. The high birefringence of the fiber results in an increased sensitivity to environmental changes. A small change in temperature can, for example, translate into significant variation of power transmission over wavelength.

To reiterate, a small change to the fiber's properties between reference and device measurement can have noticeable impact simply because these effects on power transmission in PM fiber have relatively high amplitude and short periodicity.

In conclusion, when making PDL measurement using the Mueller Method, the reference measurement is not only



relevant to recording power variation over polarization state, but also over wavelength.

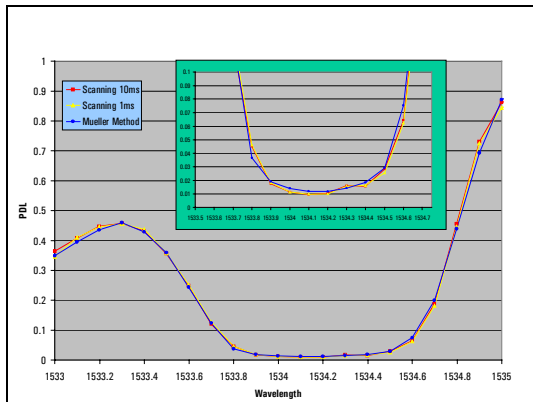

**Figure 15: PDL measurement of a grating based WDM using the Polarization Scanning technique and the Mueller Method.**

A sample measurement of a grating-based WDM filter using the Polarization Scanning technique and the Mueller Method is shown in Figure 15. The results of the various measurements compare well.

## PDL and Insertion Loss

A PDL measurement performed as described here always yields the insertion loss of the DUT. Thus, two properties of the DUT can be obtained without additional effort. Furthermore, isolation, or cross talk, can be derived from the insertion loss determination. However, the accurate measurement of device transmission characteristics requires a high dynamic range during the insertion loss measurement.

Agilent 81680A and 81640A tunable laser sources provide a low SSE output. The source spontaneous emission is attenuated by around 60dB compared to the signal level. Even if the laser signal is attenuated by the filter, and the greater part of the SSE passes through, the setup is still able to render a true measurement of the filter's rejection depth.

## PDL and Insertion Loss of multiple channels

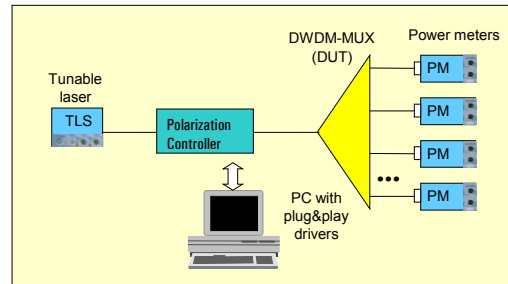

**Figure 16: Scheme of a multi-channel setup for PDL and insertion loss measurements.**

Many passive components transform one input signal containing many channels into the corresponding number of output signals containing only one channel, or vice-versa. It is desirable to characterize all output channels in parallel, in other words in one measurement. This reduces both device measurement and device handling time.

A typical setup for a multi-channel test that includes PDL measurement is shown in Figure 16. A tunable laser serves as the optical source. Either the 11896A or the 8169A polarization controller is employed for signal conditioning. The input line of the DUT is connected to the output port of the polarization controller. The output lines from the DUT are connected to power meter modules.

Automated remote control of the Agilent 816x mainframe series and related modules, such as tunable lasers or power modules, is simplified by employing the VXI plug and play driver. This driver contains an extensive library whose functions can substitute for one or more GPIB commands and provide parameter check and error handling. A continuous wavelength scan can be programmed using only three functions. These functions configure and execute the wavelength scan and yield the measurement results. All the necessary operations, such as wavelength logging or power level stitching, are performed internally by the driver.

Wavelength logging captures the real wavelength at which a power measurement is triggered. Measurements are not taken at exactly the step size that has been set because the wavelength scan is continuous. However, the plug and play driver ensures that power measurements are obtained at the equally spaced wavelength points required for PDL calculations.

Power level stitching allows measurements to be taken in a maximum of three different power ranges. The plug and play driver combines the data obtained from the three power ranges to yield a full characterization of the DUT over a wide dynamic range.

The plug and play driver can easily be integrated into software development environments.

A more detailed discussion of the state-of-the-art characterization of optical components can be found in [4].

## Interpretation of Measurement Results

The interpretation of PDL measurement results requires a deep understanding of the polarization characteristics of the DUT. The properties of integrated optical devices also depend on the polarization of the incident light wave signal. A shift in wavelength of the filter curve is one such effect. An arrayed waveguide grating (AWG) is a typical example of a device that exhibits a strong wavelength dependence in its filter curves.

An example of an insertion loss measurement at four polarization states is shown in Figure 17. Figure 18 uncovers a characteristic of the DUT (an early AWG-type WDM): the polarization dependency of the filter transmission curves. The filter transmission curves shift in wavelength for different states of polarization. Moreover, the shape of the transmission curves slightly changes for the different polarization states. The maximum shift, also known as the TE-TM<sup>1</sup> shift, of the filter curves does not correlate to the maximum and minimum transmission curves. Assume two filter curves (TE and TM), that exhibit maximum wavelength shift. At a particular wavelength, the curves cross each other; in other words they have the same power level at a particular wavelength. For other polarization states of the incident light wave, the filter curves are located between the TE and TM curves. As a result, these filter curves have a different power level compared to the TE-TM curves at their crossing point. The T<sub>max</sub> and T<sub>min</sub> curves of the device over wavelength do not correspond to the TE-TM filter curves.

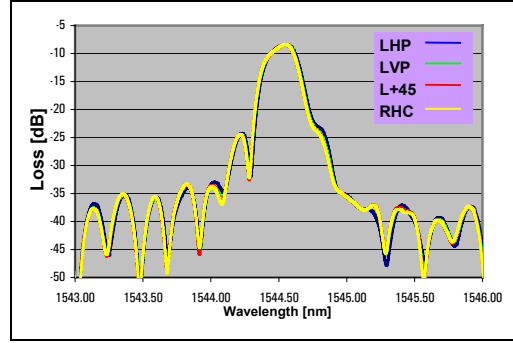

Figure 17: Polarization dependent filter transmission curves of an AWG type filter.

At two extremely small wavelength intervals, the four curves cross each other. Translated to the PDL, this corresponds to two regions with very low PDL. In turn, at the slopes of the filter curves, significant power variations occur due to the wavelength shift over polarization. This effect results in an increasing PDL. Both effects are clearly visible in Figure 19, where the PDL of the DUT is shown.

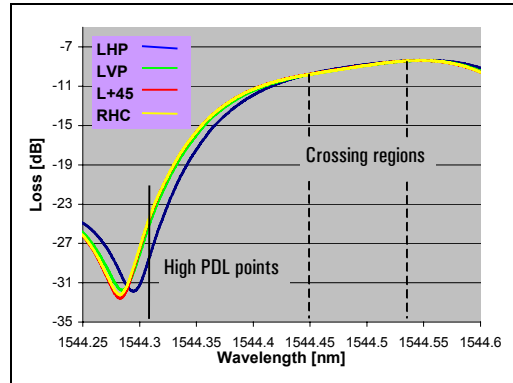

Figure 18: Zoom of transmission curves.

The points with lowest PDL correspond in wavelength to the crossing intervals of the four filter curves. However, for various reasons, the measured PDL is not zero. Firstly, the filter curves do not cross at exactly the same wavelength. Even if they did, it is questionable whether this can be captured within the resolution of the source<sup>2</sup>. Also, power noise in the system limits the performance of the setup when extremely small PDL values are measured. The finite accuracy and resolution of the setup prevents the measurement of the ideal zero PDL, if it exists.

In contrast, the steep slope in PDL is caused by power transmission differences in the wavelength-shifted filter curves. The PDL spectrum varies from 0.027dB, to more

<sup>1</sup> TE and TM represent here the two polarization eigenmodes of the waveguide.

<sup>2</sup> Maximum resolution is 0.1 pm using the Vxi plug and play driver Rev. 2.51 and higher with the tunable laser sources 81640A and 81680A.

than 14dB in the transmission band of the filter. As can be seen in Figure 19, the maximum PDL peak is followed by another minimum PDL. This PDL point corresponds to the crossing point of the filter curves at the low end of their slopes.

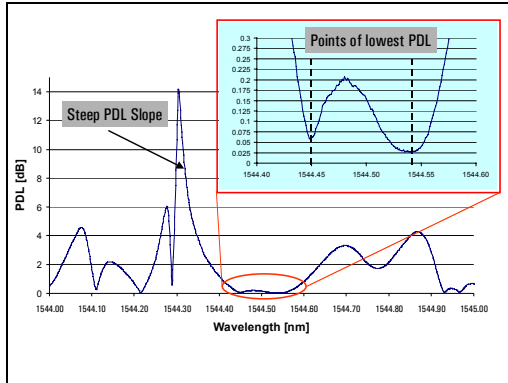

**Figure 19: PDL of an AWG-type filter channel.**

Integrated optical devices can also exhibit strong temperature dependence. A temperature change of 1 Kelvin may lead to a wavelength shift in the filter curves

of around 10pm. Therefore, it is important to keep the DUT at a constant temperature.

Nowadays, athermal AWG-type filters circumvent any temperature drifts in the filter curves.

## Summary

The Polarization Scanning technique and the Mueller Method are suitable methods for measuring the polarization dependent loss of passive optical components. Both methods can be extended to obtain the evolution of PDL over wavelength. While the Polarization Scanning technique is preferable for determining PDL at a specific wavelength, the Mueller Method has clear advantages when PDL must be characterized at numerous wavelength points with equal spacing. This method allows the use of a tunable laser source capable of continuously sweeping the wavelength range.

Both techniques yield the insertion loss characteristic of the DUT with the PDL measurement, and support parallel multi-channel testing, so are preferred methods for manufacturing tests.

## Agilent Technologies' Test and Measurement Support, Services, and Assistance

Agilent Technologies aims to maximize the value you receive, while minimizing your risk and problems. We strive to ensure that you get the test and measurement capabilities you paid for and obtain the support you need. Our extensive support resources and services can help you choose the right Agilent products for your applications and apply them successfully. Every instrument and system we sell has a global warranty. Support is available for at least five years beyond the production life of the product. Two concepts underlie Agilent's overall support policy: "Our Promise" and "Your Advantage."

### Our Promise

Our Promise means your Agilent test and measurement equipment will meet its advertised performance and functionality. When you are choosing new equipment, we will help you with product information, including realistic performance specifications and practical recommendations from experienced test engineers. When you use Agilent equipment, we can verify that it works properly, help with product operation, and provide basic measurement assistance for the use of specified capabilities, at no extra cost upon request. Many self-help tools are available.

### Your Advantage

Your Advantage means that Agilent offers a wide range of additional expert test and measurement services, which you can purchase according to your unique technical and business needs. Solve problems efficiently and gain a competitive edge by contracting with us for calibration, extra-cost upgrades, out-of-warranty repairs, and on-site education and training, as well as design, system integration, project management, and other professional engineering services. Experienced Agilent engineers and technicians worldwide can help you maximize your productivity, optimize the return on investment of your Agilent instruments and systems, and obtain dependable measurement accuracy for the life of those products.

**By internet, phone, or fax, get assistance with all your test & measurement needs**

#### Online assistance:

[www.agilent.com/comms/lightwave](http://www.agilent.com/comms/lightwave)

Phone or Fax  
United States:  
(tel) 1 800 452 4844

Canada:  
(tel) 1 877 894 4414  
(fax) (905) 206 4120

Europe:  
(tel) (31 20) 547 2323  
(fax) (31 20) 547 2390

Japan:  
(tel) (81) 426 56 7832  
(fax) (81) 426 56 7840

Latin America:  
(tel) (305) 269 7500  
(fax) (305) 269 7599

Australia:  
(fax) (61 3) 9210 5947

New Zealand:  
(tel) 0 800 738 378  
(fax) 64 4 495 8950

Asia Pacific:  
(tel) (852) 3197 7777  
(fax) (852) 2506 9284

Product specifications and descriptions in this document subject to change without notice.

Copyright © 2002 Agilent Technologies  
March, 14 2002

**5988-1232EN**

#### Related Agilent Literature:

- [1]: "Polarization dependent loss measurements using modular test system configurations", PN 5965-5720E, Agilent Technologies
- [2]: Nyman, B.; Optical Fiber Conference, OFC 1994, Technical Digest, page 230, ThK6
- [3]: "PDL Measurements using the HP8169A polarization controller", PN 5964-9937E, Agilent Technologies
- [4]: "State-of-the-Art characterization of optical components for DWDM applications", PN 5980-1454E, Agilent Technologies



**Agilent Technologies**